

Model: TTS200 series

# Tripod Turnstile

**STAINLESS STEEL TRIPOD TURNSTILE**

**Effective pedestrian access control for residential, industrial and commercial applications**

**MAG** TTS200 is a series of electro mechanical turnstiles. Its unique mechanical drive design allow the arm to be pushed effortlessly and auto-rotate back without any expensive electric motor.

**MAG** TTS200 series can effectively control high volume human traffic (up to 30 person per minutes) while still maintaining a welcoming atmoshere. They can easily be intergrated with any electronic system for ticketing, access control or time attendance.

**MAG** TTS200 series is suitable for indoor or shaded outdoor. They are optimized economical solution for railway, bus station, factory, colleges, commercial building, stadium, game park, bank and etc.

**Reliable  
Functional  
Economical**

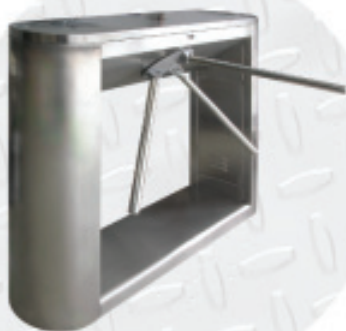

TTS260



TTS210



TTS230

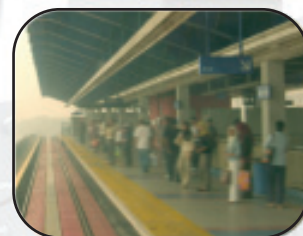

## Stainless steel pedestrian tripod turnstile

**TTS230**

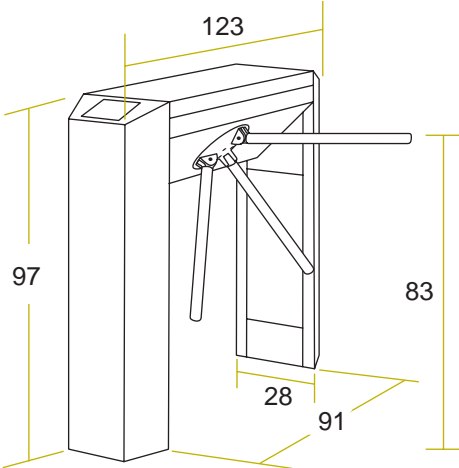

\* All measurement are in cm.

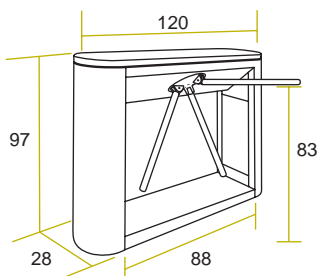

**TTS260**

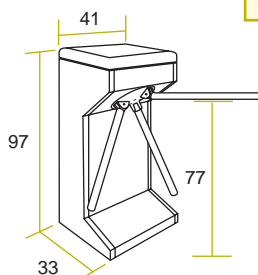

**TTS210**

Mechanical drive unit eliminate the use of expensive electric motor and reduce maintenance cost.

Turnstile can be configured to be bi-directional or uni-directional. Built in acrylic plate for easy integration with other devices.

If arm rotated more than half, it will auto-rotate to the next idle position. If arm rotated less than half, it will auto-rotate back to the current idle position.

Anti-tailgating. Smart lock mechanism effectively allow only one person to pass through at a time.

During power failure, arm will drop automatically allowing free pass through. Internal parts inside housing is key locked to avoid tampering.

Built in LED to indicate direction. Once unlock, arm just need to be pushed lightly to rotate therefore even elderly or children are able to use the turnstile.



Secure

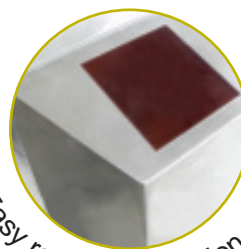

Easy reader intergration

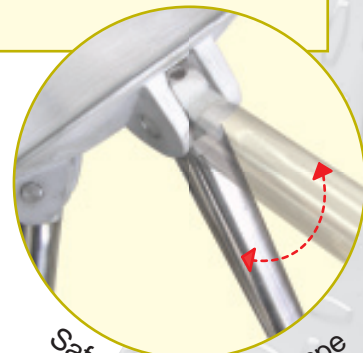

Safe, emergency escape



Versatile



User friendly

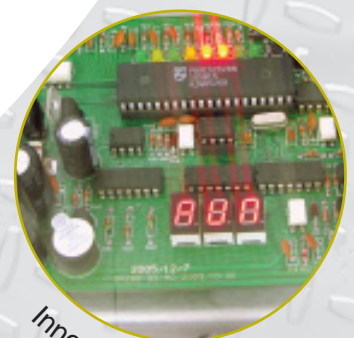

Innovative design

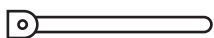

All tripod length are 52cm

### Technical specification:

Description	Specification
Power supply	AC220V $\pm$ 10V
Power consumption	25 Watt
Passage width	60 cm
Response time	0.2 sec
Pass speed	30 person per min

Authorized dealer